

Website
www.global.ilifsmart.com

Cololight Website
www.cololight.com

Business
inquiry@ilifsmart.com

Customer Service
support@ilifsmart.com

 LinkedIn: LifeSmart

 Instagram: LifeSmart(@ilifsmart)

 Facebook: LifeSmart(@ilifsmarthome)

 Twitter: LifeSmart(@ilifsmarthome)

 YouTube: LifeSmart

LifeSmart

SMART
HOME
PRODUCT



Contents

Company -----	01	Switch -----	31
CoSS Protocol		BLEND Light Switch	
AI Builder		Moonstone Switch	
Cybersecurity		Moonstone Switch 120	
App		Stellar Switch	
		Starry Switch	
		Dimmer&Motion Sensor Switch	
		Dimmer Control	
		CUBE Clicker	
		CUBE Switch Module	
Interaction Center -----	07		
Nature			
		Plug -----	41
Gateway -----	09	Smart Plug	
Smart Station		Smart Plug (EU&FR)	
Camera -----	11	Lighting -----	43
Frame		Light Strip	
Indoor Camera		Cololight	
Outdoor Camera		BLEND Light Bulb	
Smart Lock -----	15	Curtain Controller -----	49
Video Smart Door Lock		BLEND Curtain Controller	
Smart Door Lock (Classic)		MINS Curtain Motor Controller	
Yale Door Lock Module		Tubular Motor	
		QuickLink Curtain Motor	
		Smart Curtain Motor	
Sensor -----	19		
CUBE Motion Sensor		Smart Control -----	55
CUBE Environmental Sensor		Universal Remote Controller (SPOT)	
CUBE Door/Window Sensor		General Controller	
Water Leak Sensor		HA Interface Adaptor	
Gas Sensor			
Motion Sensor (AAA)			
Human Presence Sensor (Radar Detector)			
Smart HVAC -----	27		
Smart Fan Coil Thermostat Base and Panel			
Smart Underfloor Thermostat Base and Panel			
Smart Central Air-conditioning Gateway			

LifeSmart

Digitize the physical world

Every single home will become a smart home, every single office will become a smart office

LifeSmart is a leading IoT company focusing on the global smart home market, and our products and solutions have served nearly 1 million customers over 30 countries, creating values for their everyday life.

Global Awards

The superior design of our products has been awarded great prizes: CES Innovation Awards, Good Design Award, iF Design Award, etc.,

HomeKit Compatible

LifeSmart now works with Apple HomeKit. Among all the leading brands, LifeSmart has hitherto offered the most home devices to be HomeKit compatible.





Ultra Long Distance, Super Quick Speed

CoSS protocol shares multiple advantages which include better coverage, larger capacity, lower power consumption and higher security level.

800m

CoSS can achieve ultra-long distance signal transmission of 800 meters from LifeSmart smart station to other home devices.

100ms

The signal delay could be less than 100ms.

5 years

Based on CoSS, we are able to deliver the smart switch product which supports 5 years battery life with ER18505 battery.

	CoSS	ZigBee	Wi-Fi	Z-Wave
Distance	200-800m	30-100m, can cascade devices	40m	40-100m, limited cascade of devices
Power Consumption	Low	low	High	Low
Stability	High	High	High	Low
System Capacity	High(support more than 100 devices)	High	Low	Low
Bandwidth	Low (1kbps-128kbps)	High(256kbps)	Very High (>54mbps)	Low(9.6kbps/40kbps)
Radiation	Low(work instantaneously)	Medium (work instantaneously)	High (work continuously)	Medium (work instantaneously)
Reliability	High	High	High	High

AI Builder

Create Unlimited Devices Communication Policies

AI Builder is an open and flexible computing framework which fulfills the users' personalized requirements now and empowered by the cloud AI on a learning basis. With AI Builder, you are able to deliver multiple outputs with multiple sensor conditions and computing policies, to create any smart home communication rules as your imagination.

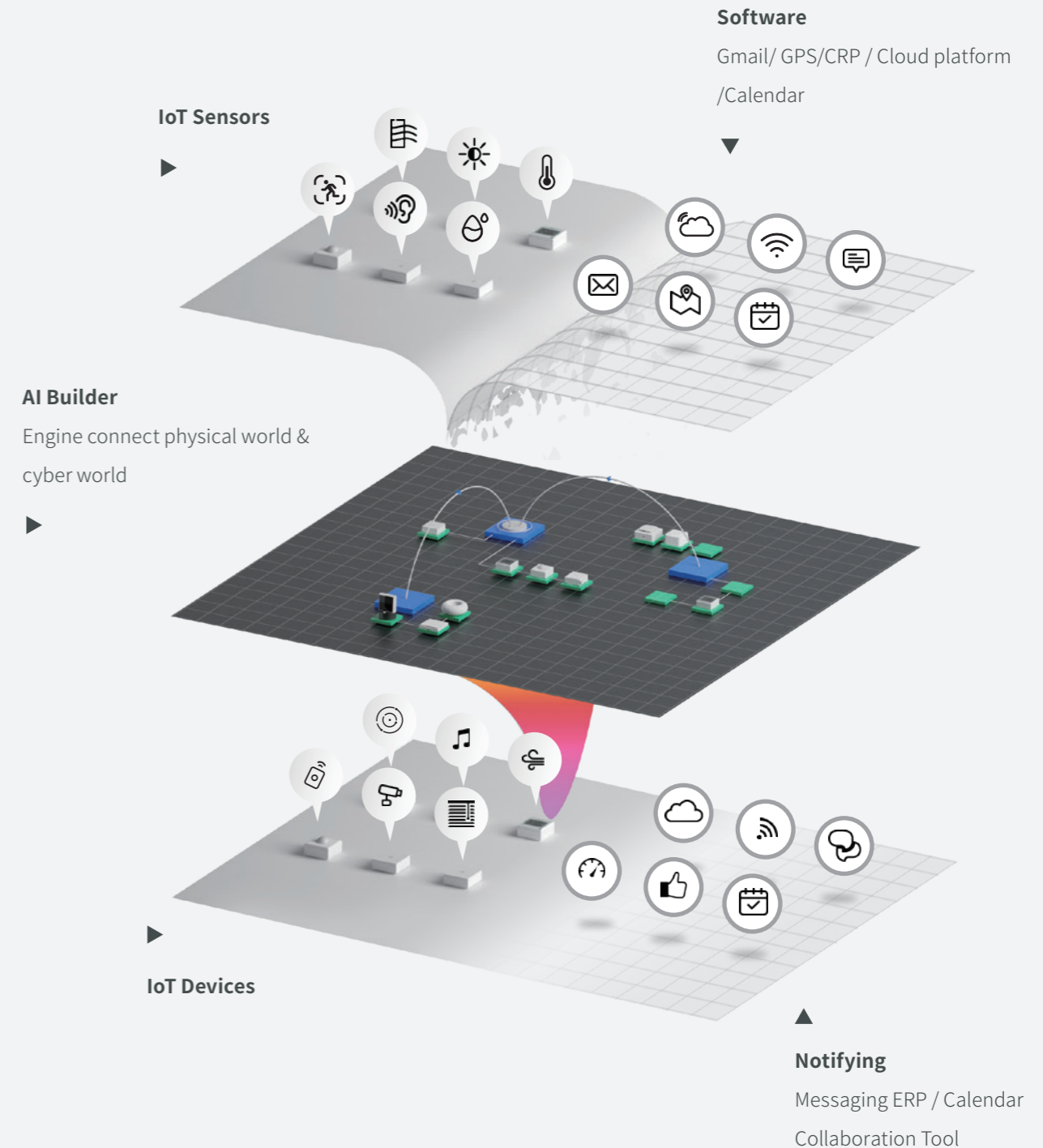

LifeSmart App

LifeSmart App supports all kinds of LifeSmart devices and other third-party ZigBee/Z-Wave devices. You may monitor and interact with your home anywhere and anytime through mobile, bringing comfort and efficiency of smart home management to a new level.

System function

Push notification, AI builder, Schedule timer, Global account, OTA upgrade, Local network access, Device share, Engineering mode, RSSI monitor, Device backup.



* Minimum system requirement Android 4.0, iOS 7.0



Cybersecurity

Bank Level Encryption and Security

LifeSmart puts the cybersecurity and privacy protection as the top priority since day one. We build our system and connection with bank level encryption and security, from the smart device, edge gateway, cloud service to the applications, all the links in between are encrypted and protected.

Privacy by Default

More over, we monitor and enforce compliance to meet industry standards and security policies such as GDPR, and we actively detect and stop the advanced threats, keep it away from our customers.

- Bank level encryption
- Z-Wave Security S2 certification
- Independent key management for every single device
- Minimum authorization management for cloud service
- All data encryption

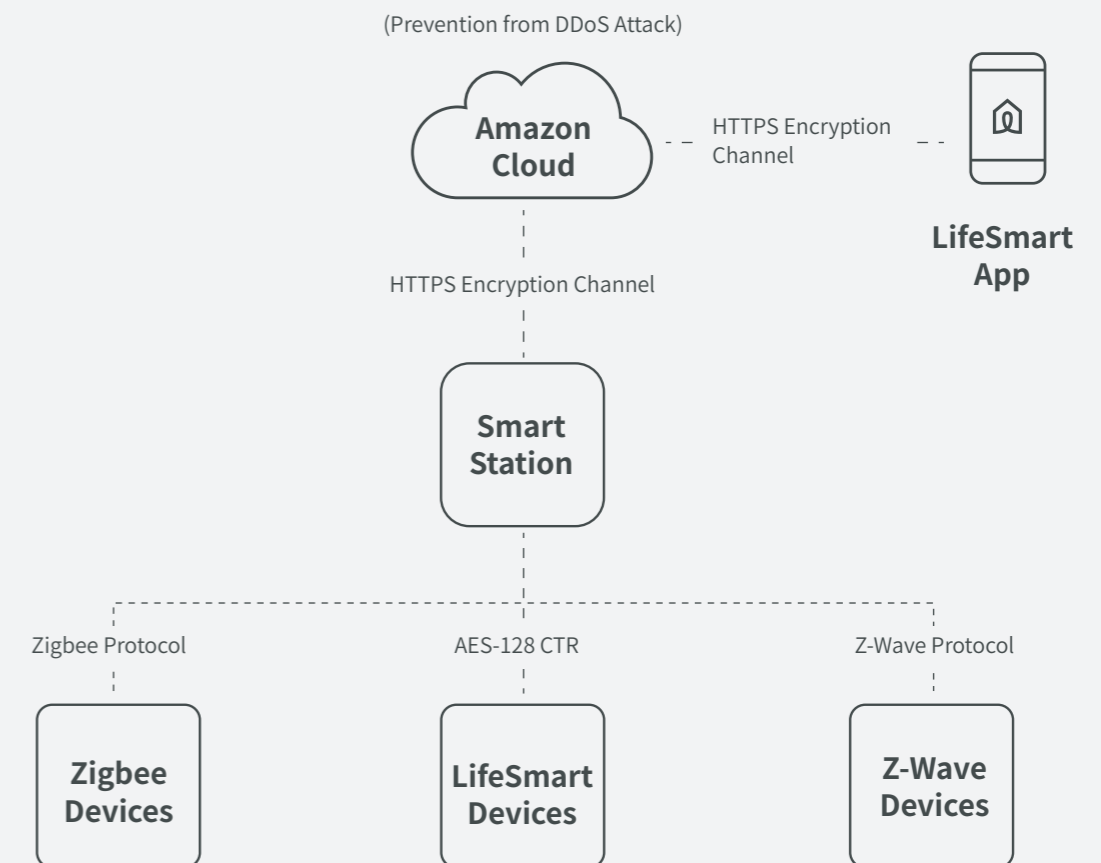





Interaction Center



The all-in-one smart terminal takes protection of you and all your properties

Nature

LS148

The all-in-one smart control panel serving as a personal butler

-  10.25" High definition touch screen
-  Configurable built-in menu to meet your needs
-  Customizable physical buttons to switch scenes
-  Elegant anodized aluminum craft

-  Voice control
-  App control
-  Communicate with other devices



General

Model Number	LS148
Installation	In-wall concealed with pre-embedded back box(standard)
Operating Temperature	-5~45°C
Operating Humidity	5~90%
Network	Wi-Fi 2.4GHz/ Ethernet
Power Consumption	<20W
Interface	Live/Neutral/Earth wire in Ethernet RJ45 HDMI in USB

Button	Customizable scene-switch button×4 Power button
Screen	10.25 inch touch screen
Resolution	1920×720
CPU	4 Core ARM
Power Supply	AC 100-240V 50/60Hz
RAM	2GB
Operating System	Android 5.1
Bluetooth	Yes (Bluetooth 4.2)
Speaker	Yes
Microphone	Yes

Construction

Color	Matte grey
Dimensions	Exposed dimension: 342*122*16mm Backbox dimension: 335*114*70mm
Weight	1260g(panel only)
Casing	Aircraft aluminum

Gateway

More than convenient
when everything gets
connected



Smart Station

LS082WH LS090WH

Center of the smart home ecosystem and make all the devices work seamlessly



Powerful processor with up to 500 connected devices



800m wireless signal distance



AI builder for automated processing



Multiple-protocol support



Voice control



App control



Communicate with other devices

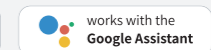
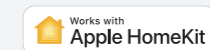

Radio	Smart Station	Smart Station (CoSS+Zigbee)	Smart Station (CoSS+Z-Wave)
Radio Protocol	CoSS	CoSS & Zigbee	CoSS & Z-Wave
Radio Frequency	433~922MHz	CoSS: 433~922MHz / Zigbee: 2.4GHz	CoSS: 433~922MHz / Z-Wave
Signal Distance (Open Field)	800m	CoSS: 800m / Zigbee: 30-100m	CoSS: 800m / Zigbee: 40-100m

General	Construction
Model Number	LS082WH
Operating Temperature	-5~45°C
Operating Humidity	5~90%
Power Supply	DC 5V
Power Consumption	<2.5W
Interfaces	Power supply 1/ RJ45 1/ Reset hole 1
Indicator	Yes
Connected Devices	500
Network	LAN(10/100/1000 BASE-T via RJ45 port)
Color	Ivory white
Dimensions	110.8*110.8*28mm
Weight	120g
Casing	ABS

Cameras





Catch every single vital moment for peace of mind





FRAME 360

LS053WH

Ultimate camera with portable wireless design, free rotation base, and new sticky notes feature

-  **1080P high definition real-time monitoring**
-  **Two-way talk**
-  **IR night view**
-  **Motion detection and alarm notifications**

 Voice control  App control  Communicate with other devices



General

Model Number	LS053WH
FOV	105°
Operating Temperature	-5~45°C
Operating Humidity	5~90%
Power supply	DC 5V
Power consumption	<3.5W
Battery	Yes, built-in 280mAh
Interface	Micro USB power input
Indicator	RGB LED*2
Ingress Protection	Indoor
Communication Protocol	Wi-Fi 2.4GHz
Button	Switch Pairing/operating button
Resolution	1080P
Compression	H.264
Night view	IR 10m
PTZ	Horizontal 360° infinite remote panning Vertical 16° manual adjustment
Motion Alarm	Yes

Audio

Two-way Talk	Yes
Audio Message	Yes
Speaker	Yes
Mic	Yes

Storage

Built-in Storage	16GB
External Storage	No





Construction



Color	Black+white
Dimension	Camera main body: 66*66*26mm Rotatable base: 66*27mm
Weight	Camera main body: 110g Rotatable base: 160g
Casing	POM / ABS+PC

Indoor Camera

LS198

An intelligent indoor camera with human detection, allowing you to monitor what matters without receiving annoying false alerts

-  **1080P high definition real-time monitoring**
-  **Two-way talk**
-  **IR night view**
-  **Motion detection and alarm notifications**

 Voice control  App control  Communicate with other devices



General	
Model Number	LS198
Fov	90°
Operating Temperature	-20°~60°
Operating Humidity	5~90%
Power Supply	DC 5V
Power Consumption	<5W
Battery	No
Interface	Micro USB power input TF card slot
Indicator	No
Ingress Protection	Indoor
Communication protocol	Wi-Fi 2.4GHz
Button	Pairing/operating button
Resolution	1080P
Compression	H.264
Night View	IR 8m
PTZ	Horizontal 355° remote panning Vertical 89° remote tilting
Motion Alarm	Yes

Audio	
Two-way Talk	Yes
Audio Message	No
Speaker	Yes
Mic	Yes





Storage	
Built-in Storage	No
External Storage	TF card



Construction	
Color	Ivory white
Dimension	78.5*78.5*115mm
Weight	180g
Casing	ABS

Outdoor Camera

LS179

1080P outdoor camera with sound-light alarm to actively guard your house 24/7

-  **1080P high definition real-time monitoring**
-  **Active deterrence with sound-light alarm**
-  **IR night view**
-  **IP66 ingress protection for outdoor installation**

 Voice control  App control  Communicate with other devices



General	
Model Number	LS179
Fov	110°
Operating Temperature	-5~45°C
Operating Humidity	5~90%
Power Supply	DC 12V
Power Consumption	<12W
Battery	No
Interface	Power port Ethernet port Antenna port TF card slot
Indicator	No
Ingress Protection	Indoor/Outdoor IP66
Communication protocol	Wi-Fi 2.4GHz
Button	Pair/operate button
Resolution	1080P
Compression	H.264
Night View	IR 10m
PTZ	Manual adjustment

Audio	
Two-way Talk	Yes
Audio Message	No
Speaker	Yes
Mic	Yes

Storage	
Built-in Storage	No
External Storage	TF card

Construction	
Color	Ivory white
Dimension	66*66*182mm(with bracket)
Weight	375g
Casing	Aluminium alloy casing

Smart Locks

A smart and visible way
to guard your home



DESIGN
AWARD
2018



Video Smart Door Lock^{LS099GS}

Innovatively featuring an HD camera built in bezel-less design with stylish finish and an emphasis on ergonomics



Multiple access



iF World Design Award



Detect break-in and entrance attempts



Video intercom



General

Model Number	LS099GS
Color	Gold / Silver
Dimensions	385*75*33mm
Weight	4175g
Casing	Glass panel, zinc alloy
Lock Case Grade	Super-B anti-theft lock case
Compatible Lock	6068 lock body
Lock Body Size	24*240 Square lock body (standard) 30*240 Round lock body (optional) 388 Series overlord lock (optional)
Open Direction	Left outer opening/ Right outer opening/ Left inner opening/ Right inner opening
Unlock Mode	Fingerprint, password, NFC card, emergency key, APP
Fingerprint Module	Biological fingerprint sensor
Rejection Rate	≤1%
False Recognition Rate	≤0.001%
Password Length	6-12 Digit
Cryptographic Function	Visitor temporary password Privacy guard password Hijacking password alarm
Storage Quantity	Fingerprint*100/ password*30/ NFC card*255
Operating Temperature	-30~60°C

Operating Humidity	20~90%
Power Supply	8 AA alkaline batteries, 12V
Emergency Power Supply	USB
Battery Life	10 times per day, last about 1 year
Interface	Micro USB emergency power interface
Button	Fingerprint button Keyboard, Reset button Code matching button Doorbell button Door lock safety knob Back cover open button
Display	LED display
Camera	Lens F2.5 Field angle: 120 ° Resolution: 640X480P Night vision: visible light compensation
Speaker	High fidelity speaker HD microphone

Radio

Radio Protocol	CoSS / Wi-Fi: for video stream
Signal Range (Open Field)	CoSS: 200m / Wi-Fi: 50m

Smart Door Lock - Classic

LS101GS/SL

A smart lock with multiple ways for access and can communicate with your home devices



Multiple access



Anti-theft lock case



Detect break-in and entrance attempts

Voice control App control Communicates with other devices



General

Model Number	LS101GS/SL
Color	Gold / Silver
Dimensions	385*75*33mm
Weight	4130g
Casing	Glass panel, zinc alloy
Lock Case Grade	Super-B anti-theft lock case
Compatible Lock	6068 lock body
Lock Body Size	24*240 Square lock body (standard) 30*240 Round lock body (optional) 388 series overlord lock (optional)
Open Direction	Left outer opening/ Right outer opening/ Left inner opening/ Right inner opening
Unlock Mode	Fingerprint, password, NFC card, emergency key
Fingerprint Module	Biological fingerprint sensor
Rejection Rate	≤1%
False Recognition Rate	≤0.001%
Password Length	6-12 Digit
Cryptographic Function	Visitor temporary password Privacy guard password Hijacking password alarm
Storage Quantity	Fingerprint*100/ Password*30/ NFC card*255

Operating Temperature	-30~60°C
Operating Humidity	20~90%
Power Supply	8 AA alkaline batteries, 12V
Emergency Power Supply	USB
Battery Life	10 times per day, last about 1 year
Interface	Micro USB emergency power interface
Button	Fingerprint button Keyboard Reset button Code matching button Doorbell button Door lock safety knob Back cover open button
Display	LED display
Camera	N/A
Speaker	High fidelity speaker
Microphone	HD microphone

Radio

Radio Protocol	CoSS
Signal Range (Open Field)	CoSS: 200m

Yale Door Lock Module

LS147

A module for connecting your classic Yale lock to your smart home system



Compatible with multiple Yale locks



Compact to be mounted inside the lock body



Upgrade classic lock to a smart one

Voice control App control Communicates with other devices



General

Model Number	LS147
Operating Temperature	-5~45°C
Operating Humidity	5~90%
Power Supply	Power supply by Yale door lock
Installation	Inside the Yale lock
Compatible Yale Lock Model	YDR413, YDM4216, YDM4111, YDM4109, YMF40, YDM7216, YDM7116, YMG40, V-F, V-FR
Interfaces	8 pin

Radio

Radio Protocol	CoSS
Signal Range (Open Field)	100m

Construction

Color	Ivory white
Dimensions	18*18*50mm
Weight	8g
Casing	ABS

Sensors





Stable operation, stay connected





CUBE Motion Sensor

LS062WH

A tiny Motion sensor combined PIR technology and light detection

-  120° wide angle detection
-  Built-in light sensor to switch day/night mode
-  Notifications and record searching via the app
-  Compact size and could be placed anywhere

 Voice control  App control  Communicats with other devices



General

Model Number	LS062WH
Operating Temperature	-5~45°C
Operating Humidity	5~90%
Power Supply	1 Battery CR2450, 3V
Static Consumption	<1mW
Battery Life	Up to 1 year
Sensitive Element	Passive infrared sensor, light sensor
Detection	3m/120°
Interface	-
Button	-
Indicator	LED
Display	-
Audio	-

Radio

Radio Protocol	CoSS
Signal Range (Open Field)	100m

Construction

Color	Ivory white
Dimensions	38.4*38.4*22.4mm
Weight	20 g
Casing	ABS+PC

CUBE Environmental Sensor LS063WH

One device to simultaneously monitor the temperature, humidity and illumination and indicate these data with a LCD display



Built-in multiple sensors including temperature detection, humidity detection and light detection



Real-time data display on the screen



Notifications and record searching via the app



Tiny size and could be placed anywhere



Voice control App control Communicats with other devices

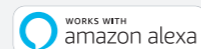
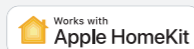

General	
Model Number	LS063WH
Operating Temperature	-5~45°C
Operating Humidity	5~90%
Power Supply	1 Battery CR2450, 3V
Static Consumption	<1mW
Battery Life	Up to 1 year
Sensitive Element	Temperature sensor, humidity sensor, light sensor
Detection	Temperature, humidity, light
Interface	-
Button	Pairing button
Indicator	LED
Display	LCD
Audio	-

Radio	
Radio Protocol	CoSS
Signal Range (Open Field)	100m

Construction	
Color	Ivory white
Dimensions	38.4*38.4*16.2mm
Weight	24g
Casing	ABS+PC

CUBE Door/Window Sensor LS058WH

A simple-to-install door/window sensor combined magnetic sensor and vibrating sensor



Remote alarm once opening or vibrating detected



Real-time feedback on door/window status



Notifications and record searching via the app



One-button for scenes control



Voice control App control Communicats with other devices



General	
Model Number	LS058WH
Operating Temperature	-5~45°C
Operating Humidity	5~90%
Power Supply	1 Battery CR2450, 3V
Static Consumption	<1mW
Battery Life	Up to 1 year
Sensitive Element	Magnetic sensor, vibration sensor
Detection	Slide and shake detection of the door and window
Interface	-
Button	Customizable button, pairing button
Indicator	LED
Display	-
Audio	-



Radio	
Radio Protocol	CoSS
Signal Range (Open Field)	100m

Construction	
Color	Ivory white
Dimensions	38.4*38.4*14.6mm
Weight	20g
Casing	ABS+PC



Water Leak Sensor

LS064WH

Ensure safety and the comfort of use when there is water leak

-  Water leak detection
-  Real-time monitoring of your house safety
-  Notifications and record searching via the app



-  Voice control
-  App control
-  Communicates with other devices

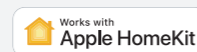

General	
Model Number	LS064WH
Operating Temperature	-5~45°C
Operating Humidity	5~90%
Detecting Types	Water leak
Sensors	Leak sensor
Power Supply	1 Battery CR2450, 3v
Power Consumption	Static consumption<30μw Alarm consumption<100mw
Battery Life	Up to 1 year
Interface	Water sensing probe
Button	Pairing button
Indicator	LED
Display	-
Sound Alarm	-





Radio	
Radio Protocol	CoSS
Signal Range (Open Field)	100m

Construction	
Color	Ivory white
Dimensions	50*72*20mm
Weight	31g
Casing	ABS+PC



Gas Sensor

LS086WH

A gas sensor with sound alarm for immediate notifying

-  Multi-type gas detection including methane, natural gas and biogas
-  Real-time monitoring of your house safety
-  Notifications and record searching via the app
-  Built-in sound alarm



-  Voice control
-  App control
-  Communicates with other devices

General	
Model Number	LS086WH
Operating Temperature	-5~45°C
Operating Humidity	5~90%
Detecting Types	Methane, natural gas, biogas
Sensors	Gas sensor Concentration range: 300~10000ppm Sensitivity adjustable
Power Supply	DC 5V
Power Consumption	450mW
Battery Powered	No
Battery Type	-
Interface	Micro usb power supply ×2 (Two orientations, only need to connect one of them)
Button	Self-checking button Pairing button
Indicator	LED
Sound Alarm	Alarm speaker Alarm sound pressure>70db/m





Radio	
Radio Protocol	CoSS
Signal Range (Open Field)	200m



Construction	
Color	Ivory white
Dimensions	71*71*32mm
Weight	55g
Casing	ABS

Motion Sensor - AAA

LS085WH

A Motion sensor combined PIR technology and light detection

-  120° wide angle detection
-  Built-in light sensor to switch day/night mode
-  Notifications and record searching via the app
-  Compact size and could be placed anywhere

 Voice control  App control  Communicate with other devices

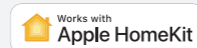

General	
Model Number	LS085WH
Operating Temperature	-5~45°C
Operating Humidity	5~90%
Power Supply	2 AAA battery, 3V
Static Consumption	<1mW
Battery Life	Up to 2 years
Sensitive Element	Passive infrared sensor, light sensor
Detection	4m/120°
Interface	-
Button	-
Indicator	LED
Display	-
Audio	-





Radio	
Radio Protocol	CoSS
Signal Range (Open Field)	200m



Construction	
Color	Ivory white
Dimensions	70*70*34mm
Weight	46g
Casing	ABS

Human Presence Sensor - Radar Detector

LS189

Adopt microwave radar technology to sensitively detect human motion

-  Extremely high sensitivity
-  Super wide detection range of up to 10 meters
-  Notifications and record searching via the app
-  Not affected by temperature

 Voice control  App control  Communicate with other devices

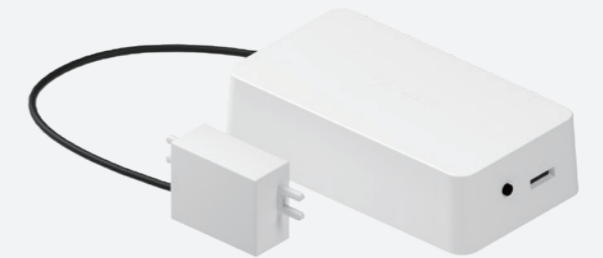

General	
Model Number	LS189
Operating Temperature	-5~45°C
Operating Humidity	5~90%
Power Supply	DC 5V
Static Consumption	<0.6W
Battery Life	Up to 2 years
Sensitive Element	24~24.25GHz radar
Max. Detection Distance	Up to 10m

Radio	
Radio Protocol	CoSS
Signal Range (Open Field)	200m



Construction	
Color	Ivory white
Dimensions	Detector: 26*12*23mm Power supply module: 83*22*47mm Connector length: 350mm
Weight	48g
Casing	ABS



Smart HVAC

Save energy, save money

Smart Central Air-conditioning Gateway ^{LS175}

Connect VRV central AC to LifeSmart system with AC gateway

-  Smart temperature adjustment
-  Energy consumption saving
-  Scheduled task

 Voice control  App control  Communicate with other devices

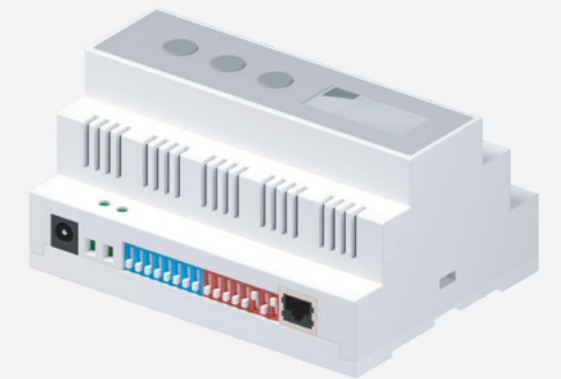

General

Model Number	LS175
Operating Temperature	-20~85°C
Operating Humidity	<80%
Power Supply	DC 12V
Static Consumption	<1.2W
Maximum Overload	-
Indicator	Yes
Display	Backlit display
Installation Method	-
Interface	Control output*14 DC power in, RJ45
Button	Dial switch*2 Set, Up, Down

Radio

Radio Protocol	CoSS
Signal Range (Open Field)	100m

Function Info



Mode	Cooling / heating / ventilation / dehumidification
Temperature Range	19-30°C
Set Stepping	1°C
Measurement Accuracy	-
Temperature Sensor	-



Construction

Color	White
Dimensions	105*86*58mm
Weight	200g
Casing	Flameresitant ABS

Smart Fan Coil Thermostat ^{LS131}

Perfectly integrated into the FCU central air-conditioning smart control system

-  Smart temperature adjustment
-  Energy consumption saving
-  Scheduled task support

 Voice control  App control  Communicats with other devices



General	
Model Number	LS131
Operating Temperature	-5~45°C
Operating Humidity	5~90%
Power Supply	AC 230V 50/60Hz
Power Consumption	1W
Maximum Overload	3A
Indicator	-
Display	Backlit display
Installation	Flush mount
Interface	Neutral wire in, Live wire in, Valve open interface, Valve close interface, High speed interface, Medium speed interface, Low speed interface,
Button	Mode button, Fan speed button, Power button, Up button, Down button,



Radio	
Radio Protocol	CoSS
Signal Range (Open Field)	100m



Function Info	
Mode	Cooling / Heating / Ventilation
Temperature Range	16-32°C
Set Stepping	0.5°C
Measurement Accuracy	0.1°C
Temperature Sensor	Thermistor B=3380 10K@25°C

Construction	
Color	White / Gold / Silver (optional)
Dimension	86*86*50mm 70.9*70.9*44.5mm (without frame)
Weight	110g
Casing	Flameresitant PC

Smart Underfloor Thermostat ^{LS130}

Essential for your family's comfort in cold winter

-  Smart temperature adjustment
-  Energy consumption saving
-  Scheduled task support

 Voice control  App control  Communicats with other devices



General	
Model Number	LS130
Operating Temperature	-5~45°C
Operating Humidity	5~90%
Power Supply	AC 100-250V 50/60Hz
Power Consumption	1W
Maximum Overload	10A
Indicator	-
Display	Backlit display
Installation	Flush mount
Interface	Neutral wire in, Live wire in Valve open, R25C/10K3380*2 System clock button
Button	Menu button, Power button Up button, Down button

Radio	
Radio Protocol	CoSS
Signal Range (Open Field)	100m

Function Info	
Mode	Internal temperature control
	External temperature control
	Dual-temperature control
Temperature Range	Internal 5-35°C External 0-90°C
Set Stepping	0.5°C
Measurement Accuracy	0.1°C
Temperature Sensor	Thermistor B=3380 10K@25°C

Construction	
Color	White / Gold / Silver (optional)
Dimension	86*86*50mm 70.9*70.9*44.5mm (without frame)
Weight	180g
Casing	Flameresitant PC

Switches

Siri-controlled switches
free your hands

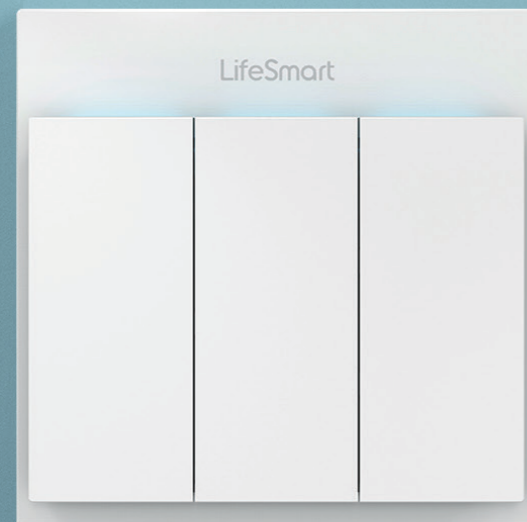

BLEND Smart Switch

LS055WH/GD/BL LS056WH/GD/BL LS057WH/GD/BL

Replace your traditional switch to the smart one and make the lights freely controlled



Simple modern design



Customized 16 million colors panel light



Dual control, multiple control



Voice control



App control



Communicats with other devices

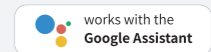
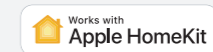

General

Wiring	Live+neutral
Control Unit	16A magnetic latching relay
Operating Temperature	-5~45°C
Operating Humidity	5~90%
Power Supply	AC 100-240V 50/60Hz
Static Consumption	<1.5W
Maximum Overload	Resistive load: 500W per channel Inductive/Capacitive load: 200W per channel
Indicator	16Million colors, brightness adjusted

Radio

Radio Protocol	CoSS
Signal Range (Open Field)	200m

BLEND Light Switch (1 gang)

Model Number	LS055WH/GD/BL
Weight	100g

BLEND Light Switch (2 gang)

Model Number	LS056WH/GD/BL
Weight	110g

BLEND Light Switch (3 gang)

Model Number	LS057WH/GD/BL
Weight	120g



Construction



Color	White / Black / Golden
Dimension	86*86*36.5mm
Casing	ABS+PC

Moonstone Switch

LS139WH/BL LS140WH/BL LS141WH/BL

Touchable switch leads you into a simple smart life

-  Simple modern design, jade like touch
-  Vibration interactions
-  Customized 16 million colors indicator light
-  Dual control, multiple control

 Voice control  App control  Communicate with other devices

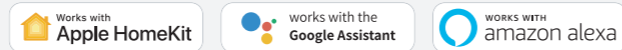

General

Wiring	Live+neutral
Control Unit	16A magnetic latching relay
Operating Temperature	5~45°C
Operating Humidity	5~90%
Power Supply	AC 100-240V 50/60Hz
Static Consumption	<1.5W
Maximum Overload	Resistive load: 500W per channel Inductive/Capacitive load: 200W per channel
Indicator	16Million colors

Construction

Color	White glass+Golden frame/ White glass+White frame/ Black glass+Golden frame
Dimension	86*86*36mm
Casing	Bottom cover: PC, top cover: ABS+PC, front panel: glass

Moonstone Switch (1 gang)

Model Number	LS139WH/BL
Weight	136g

Moonstone Switch (1 gang)

Model Number	LS140WH/BL
Weight	141g

Moonstone Switch (1 gang)

Model Number	LS141WH/BL
Weight	148g





Radio



Radio Protocol	CoSS
Signal Range (Open Field)	200m

Moonstone Switch 120

LS139WH/BL LS140WH/BL LS141WH/BL

Touchable switch leads you into a simple smart life

-  Simple modern design, jade like touch
-  Vibration interactions
-  Customized 16 million colors indicator light
-  Dual control, multiple control

 Voice control  App control  Communicate with other devices

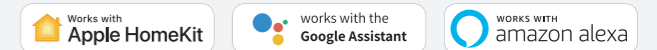

General

Wiring	Live+neutral
Control Unit	16A magnetic latching relay
Operating Temperature	5~45°C
Operating Humidity	5~90%
Power Supply	AC 100-240V 50/60Hz
Static Consumption	<1.5W
Maximum Overload	Resistive load: 500W per channel Inductive/Capacitive load: 200W per channel
Indicator	16Million colors

Construction

Color	White glass+White frame/ Black glass+White frame
Dimension	86*86*36mm
Casing	Bottom cover: PC, top cover: ABS+PC, front panel: glass

Moonstone Switch 120 (1 gang)

Model Number	LS123WH/BL
Weight	151g

Moonstone Switch 120 (1 gang)

Model Number	LS124WH/BL
Weight	158g

Moonstone Switch 120 (1 gang)

Model Number	LS125WH/BL
Weight	167g

Radio



Radio Protocol	CoSS
Signal Range (Open Field)	200m

Stellar Switch

LS170WH/GD LS171WH/GD LS172WH/GD LS173WH/GD

Independent power supply, perfect solution for live only wiring

-  Human engineering design for comfortable touch
-  No flicker, safe and stable
-  No need to damage your wall for extra wiring
-  Dual control, multiple control

 Voice control  App control  Communicate with other devices

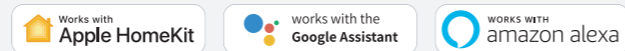

General

Control Unit	16A magnetic latching relay
Operating Temperature	-5~45°C
Operating Humidity	5~90%
Power Supply	DC 5V-30V Or AC 90-250V
Static Consumption	<1mW
Maximum Overload	Resistive load: 500W per channel Inductive/Capacitive load: 200W per channel DC load: 30V/5A
Battery Type	ER18505M(substitute: CR17505 or ER17505)
Battery Life	5 years

Radio

Radio Protocol	CoSS
Signal Range (Open Field)	200m

Construction

Color	White / Golden
Dimension	86*86*39mm
Casing	ABS+PC

Stellar Switch (1 gang)

Model Number	LS170WH/GD
Wiring	Live only / Live+neutral
Weight	115g

Stellar Switch (2 gang)

Model Number	LS171WH/GD
Wiring	Live only / Live+neutral
Weight	124g

Stellar Switch (3 gang)

Model Number	LS172WH/GD
Wiring	Live only / Live+neutral
Weight	133g

Dual Control Only



Model Number	LS173WH/GD
Wiring	No wiring
Weight	99g

Starry Switch

LS185WH/BL/GD LS186WH/BL/GD LS187WH/BL/GD

Independent power supply, perfect solution for live only wiring

-  Human engineering design for comfortable touching
-  No flicker, safe and stable
-  No need of external wiring
-  Dual control, multiple control

 Voice control  App control  Communicate with other devices

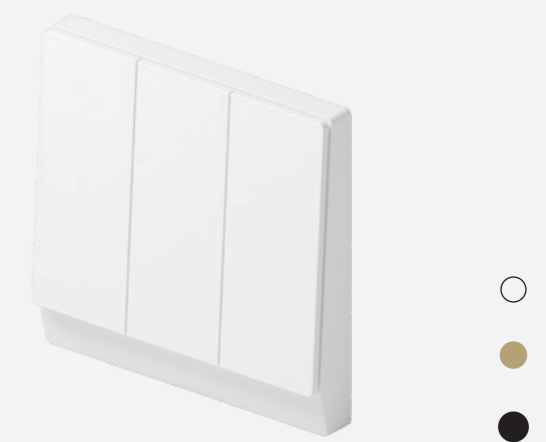
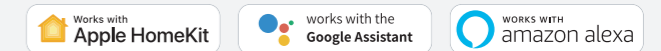

General

Control Unit	16A magnetic latching relay
Operating Temperature	-5~45°C
Operating Humidity	5~90%
Power Supply	DC 5V-30V Or AC 90-250V
Static Consumption	<1mW
Maximum Overload	Resistive load: 500W per channel Inductive/Capacitive load: 200W per channel DC load: 30V/5A
Battery Type	ER18505M(substitute: CR17505 or ER17505)
Battery Life	5 years

Radio

Radio Protocol	CoSS
Signal Range (Open Field)	200m

Construction

Color	White / Black / Golden
Dimension	86*86*39mm
Casing	ABS+PC

Starry Switch (1 gang)

Model Number	LS185WH/BL/GD
Wiring	Live only / Live+neutral
Weight	126g

Starry Switch (2 gang)

Model Number	LS186WH/BL/GD
Wiring	Live only / Live+neutral
Weight	135g

Starry Switch (3 gang)

Model Number	LS187WH/BL/GD
Wiring	Live only / Live+neutral
Weight	144g



Dual Control Only



Model Number	LS188WH/BL/GD
Wiring	No wiring
Weight	110g

Dimmer & Motion Sensor Switch

LS174

Customize your own brightness with motion detection

-  Multiple ways of lighting adjustment
-  Automatically switch on and off by human motion detection
-  Precise brightness control by percentage

 Voice control  App control  Communicate with other devices

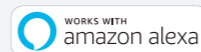
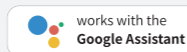



General	
Product Type	Wall mount switch
Wiring	Live+neutral
Control Unit	Triac control unit(one way)
Compatible Lights	Filament, halogen, LED lamp or other lamp with triac control
Operating Temperature	-5~45°C
Operating Humidity	5~90%
Power Supply	AC 100-240V 50/60Hz
Static Consumption	<1W
Maximum Overload	Resistive load: 250W Inductive/Capacitive load: 200W
Button	Dimmer button (Pressable) pairing&matching button Safety button
Indicator	Dimmer indicator light
Motion Detection	Yes (embedded motion sensor)
Light Detection	Yes (embedded light sensor)



Dimmer&Motion Sensor Switch (CoSS)	
Model Number	LS174
Radio Protocol	CoSS
Radio	
Signal Range (Open Field)	100m
Construction	
Color	Ivory white
Dimension	120*70*47mm (with dimmer button) 68*40*27mm (flush-mount)
Weight	110g
Casing	Bottom cover: PC , others: ABS+PC

Dimmer Control

LS180

Customize your own brightness with motion detection

-  Easy pairing
-  Indicator LED
-  Precise brightness control by percentage

 Voice control  App control  Communicate with other devices



General	
Model Number	LS180
Wiring	Live+neutral
Control Unit	0/1-10V Dimmer control(One way)
Compatible Lights	0/1-10V Dimmer control lamp, maximal 50 lamps(within 100mA)
Operating Temperature	-5~45°C
Operating Humidity	5~90%
Power Supply	AC 100-240V 50/60Hz
Static Consumption	<1W
Maximum Overload	-
Button	Pairing button
Indicator	LED
Motion Detection	Yes
Light Detection	Yes

Radio	
Radio Protocol	CoSS
Signal Range (Open Field)	100m
Construction	
Color	Pearl white
Size	111.5*42.5*24mm
Weight	55g
Casing	PC

CUBE Clicker

LS069WH/RD/WG

A simple click to run complex scenes



Compact size and could be placed anywhere





Easily switch to different scenes



Multiple color options(White/Red/Wood)



 Voice control  App control  Communicats with other devices

General	
Model Number	LS069WH/RD/WG
Operating Temperature	-5~45°C
Operating Humidity	5~90%
Power Supply	1 Battery CR2450, 3V
Battery Life	Up to 1 year
Button	Control button pairing button
Indicator	LED

Radio	
Radio Protocol	CoSS
Signal Range (Open Field)	100m

Construction	
Color	White / Red / Wood
Size	38.4*38.4*14.6mm
Weight	20g
Casing	ABS+PC

CUBE Switch Module

LS175

Make traditional switch into a smart one



The most compact smart switch module ever





Update a traditional switch to a smart one

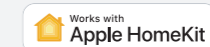

Strong compatibility to different switch size



 Voice control  App control  Communicats with other devices

Radio	
Radio Protocol	CoSS
Signal Range (Open Field)	100m

General	
Operating Temperature	-5~45°C
Operating Humidity	5~90%
Power Supply	AC 100-240V 50/60Hz
Static Consumption	<0.3W
Maximum Overload	Resistive load 300w per channel inductive/capacitive lead:150w per channel
Indicator	LED
Button	Pairing button
Wiring	Live+neutral

Construction	
Color	Ivory white
Casing	PC

One Way	
Model Number	LS176
Control unit	8A magnetic latching relay (one way)
Size	42*32*16mm
Weight	20g

Two Way	
Model Number	LS177
Control unit	8A magnetic latching relay
Size	42*32*16mm
Weight	25g





Three Way	
Model Number	LS193
Control Unit	16A Magnetic latching relay
Size	47*44*22mm
Weight	50g



Smart Plug

LS002

Smart remote control, changing traditional electronic appliances to be smart ones

-  Easy pairing
-  Scheduled task
-  Secure casing with flameresistant material



 Voice control  App control  Communicate with other devices

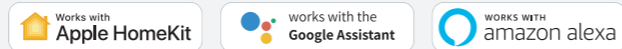

General

Model Number	LS002
Operating Temperature	-5~45°C
Operating Humidity	5~90%
Power Supply	AC 100-240V 50/60Hz
Static Consumption	<0.5W
Maximum Overload	10A
Button	Pairing/operating button
Indicator	Brightness adjustable LED
Electricity Metering	No
Manual Control	Yes
Installation	Plug and play
Socket Standard	New national standard 2/3 holes mutual socket

Radio

Radio Protocol	CoSS
Signal Range (Open Field)	200m



Construction

Color	Ivory white
Dimension	65*65*36mm
Weight	95g
Casing	Flameresistant PC



Smart Plug - EU&FR

LS159

EU&FR standard plug, changing traditional electronic appliances to be smart ones

-  Energy-consumption monitoring
-  Scheduled task support
-  Secure casing with flameresistant material



 Voice control  App control  Communicate with other devices

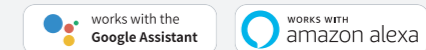

General

Model Number	LS159
Operating Temperature	-5~45°C
Operating Humidity	5~90%
Operating Voltage	AC 100-240V 50/60Hz
Static Consumption	≤0.5W
Maximum Overload	16A
Button	Pairing/operating button
Indicator	RGB LED
Electricity Metering	Yes
Manual Control	Yes
Installation	Plug and play
Socket Standard	EU & FR socket

Radio

Radio Protocol	CoSS
Signal Range (Open Field)	200m

Construction

Color	Ivory white
Dimension	61*61*84mm
Weight	95g
Casing	Flameresistant PC

Lightings

Dim the lights without lifting a finger



Light Strip

LS065

A perfect 16 million colors lighting strip with adjustable brightness and preset modes to provide different atmospheres



Low power LED technology



16 Million colors to create various lighting effects



Brightness adjustment



Voice control



App control



Communicats with other devices

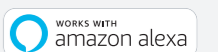
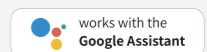
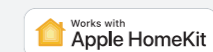

General

Model Number	LS065
Lighting Color	16 million colors + white
Lamp Model	-
Luminous Flux	360lm
Operating Temperature	-5~45°C
Operating Humidity	5~90%
Power Supply	DC 24V
Power Consumption	<12W/m

Radio

Radio Protocol	CoSS
Signal Range (Open Field)	200m

Construction

Color	-
Dimensions	2000*12*3.5mm
Weight	Light strip weight:114g/2meters

Cololight

Design your own style and treat yourself with a unique lighting experience



Create your own design with the modular light panels



16 Million colors to create various lighting effects



A music visualizer-Cololight syncs with your music



Infinite splicing without limitation

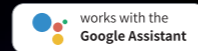





Construction	Cololight PLUS (HomeKit Set)	Cololight PRO (Starter Set)	Cololight PRO (Stone Set)
Model Number	LS167	LS166A3	LS166A6
Model Content	Homekit main controller Cololight Connector Fixator	Main controller*1 Cololight*3 Plastic base*1 Connector*3	Main controller*1 Cololight*6 Stone base*1 Connector*6 Fixator*4
Housing Color		Ivory white	
Module Size	Led module:86*74.5*30.5mm Homekit controller:46.5*30.5*28mm Fixator:16.5*17.5*9mm Connector:23.1*17.5*9mm	Led module:86*74.5*30.5mm Controller:73.1*45*8.9mm Plastic base:168.2*63.1*23mm Fixator:16.5*17.5*9mm Connector:23.1*17.5*9mm	Led module:86*74.5*30.5mm Controller:73.1*45*8.9mm Stone base:86*86*61mm Fixator:16.5*17.5*9mm Connector:23.1*17.5*9mm
Weight	Led module:52.5g Homekit controller:54g Fixator:2g Connector:2.6g	Led module:52.5g Controller:30g Plastic base:35.5g Fixator:2g Connector:2.6g	Led module:52.5g Controller:30g Stone base:550g Fixator:2g Connector:2.6g
Casing		Upper cover: ABS; others: ABS+PC	

General	
Led Color	16 Million color
Operating Temperature	-5~45°C
Operating Humidity	5~90%
Power Supply	DC 5V 2A (each 10 light units require 1 ampere extra power)
Power Consumption	0.3W at lowest, max. <5W
Maximal Connecting Led Module	Up to 255 units per controller
Radio Protocol	Wi-Fi 2.4GHz
Touch Button	Yes, on the main controller
Number of LEDs Per Module	19 Led lights in one Cololight module, can be individually controlled
Features	app control, touch button control, bluetooth pairing, timer function, group control, play library for multiple effects



Cololight (Extension)	
Model Number	LS161
Model Content	Cololight Connector

BLEND Light Bulb - E27 ^{LS024}

A perfect 16 million colors lighting bulb with adjustable brightness and preset modes for lighting up your home

-  Low power LED technology
-  16 Million colors to create various lighting effects
-  Brightness adjustment
-  Good design with capsule casing



 Voice control  App control  Communicats with other devices

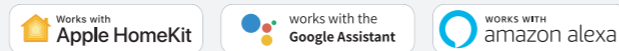

General	
Model Number	LS024
Lighting Color	16 million colors + white
Lamp Model	E27
Luminous Flux	220lm
Operating Temperature	-5~45°C
Operating Humidity	5~90%
Power Supply	AC 100-240V 50/60Hz
Power Consumption	Static consumption < 0.5W Nominal consumption: 6W (RGB 3W, white 3W)



Radio	
Radio Protocol	CoSS
Signal Range (Open Field)	200m

Construction	
Color	Silver
Dimensions	φ50*110mm
Weight	78g
Casing	Aluminum alloy



Light Bulb -E26

LS156

Light up your home by adjusting brightness and white color temperature remotely.

-  Low power LED technology
-  Brightness adjustment
-  Good design with capsule casing



 Voice control  App control  Communicats with other devices

General	
Model Number	LS156
Lighting Color	White CCT3000-6500K
Lamp Model	E26
Luminous Flux	800lm
Operating Temperature	-5~45°C
Operating Humidity	5~90%
Power Supply	AC 90-130V 50/60Hz
Power Consumption	Maximum consumption: 9W

Radio	
Radio Protocol	CoSS
Signal Range (Open Field)	200m

Construction	
Color	Ivory white
Dimensions	φ60*108mm
Weight	46.5g
Casing	PC+PBT

Curtain Controllers
Embrace the morning
sunshine while lying in bed

MINS Curtain Motor Controller ^{LS178}

Turn your traditional curtain motor into a smart one



No need to damage your wall for extra wiring



Upgrade the motors of garage door easily



Scheduled task



Accurate control by percentage



Voice control



App control



Communicates with other devices



General

Model Number	LS178
Control Unit	Relay: 2A magnetic latching
Operating Temperature	-5~45°C
Operating Humidity	5~90%
Power Supply	DC 3V
Static Consumption	<1mW
Battery Model	2 AA Batteries
Interface	RJ11 input RJ11 output 10 Pin input 10 Pin output

Construction

Color	Ivory white
Dimensions	135*32*23mm
Weight	55g (excluding battery)
Casing	ABS+PC

Radio

Radio Protocol	CoSS
Signal Range (Open Field)	100m

BLEND Curtain Controller

LS074WH
LS074GD
LS074BL

A good design panel for curtains' easy control



Simple Modern Design



One tap to control the whole shading system



Scheduled task



Accurate control by percentage



Voice control App control Communicats with other devices



General

Model Number	LS074WH / LS074GD / LS074BL
Wiring	Live+neutral
Control Unit	16A magnetic latching relay
Operating Temperature	-5~45°C
Operating Humidity	5~90%
Power Supply	AC 100-240V 50/60Hz
Static Consumption	<1.5W
Maximum Overload	Max. 500W
Indicator	16 million colors
Interface	Neutral wire input Live wire input Opening signal input Closing signal input

Construction

Color	White / Golden / Black
Dimensions	86*86*36.5mm
Weight	110g
Casing	ABS+PC

Radio

Radio Protocol	CoSS
Signal Range (Open Field)	200m

Tubular Motor

WSER40Q-8/23 WSER40Q-8/19

Integrate the roller blinds into your smart home system



Quiet motor with operating sound below 30.4dB



One tap to control the whole shading system



Scheduled task support



Accurate control by percentage

Voice control App control Communicats with other devices

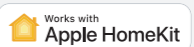

WSER40Q-8/23

Output Speed	23 rpm
Power Supply	AC 230V / AS120V 0.88A 0.53A
Power Consumption	103W

WSER40Q-8/19

Output Speed	19 rpm
Power Supply	AC 230V, 0.53A
Power Consumption	103W

Construction

Color	White
Dimensions	φ39*555mm
Weight	1.34Kg
Casing	Steel

Radio

Radio Protocol	CoSS
Signal Range (Open Field)	200m





General

Wiring	Live+neutral+ground
Rated Torque	8 N.m
Running Time	4 min
Operating Temperature	-5~45°C
Operating Humidity	5~90%
Power Cable Length	125cm
Button	Pair button
Indicator	-
Ingress Protection	IP44
Strong Power	Yes
Weak Power	Yes
Receiver Control	Yes
Electronic Limit Swtich	Yes
Manual Contraol	Yes
3rd Intermediate Limit Position	Yes
Obstacle Stop Function	Yes
Hand Operable During Power-off	Yes
Auto End Limits Setting	Yes



QuickLink Curtain Motor

BCM100D

Turn your traditional curtains into smart ones

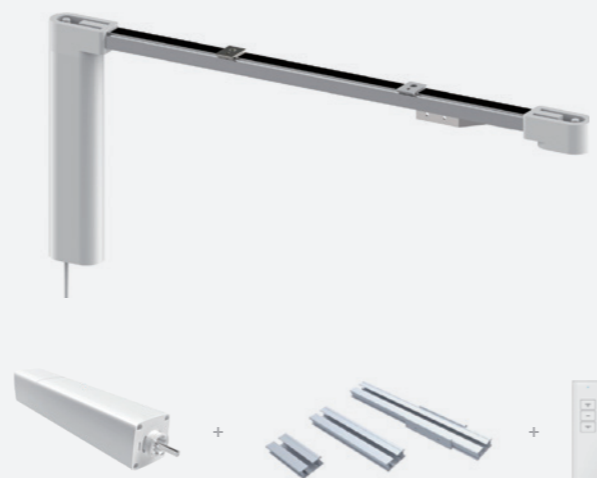
-  Adjustable track length
-  One tap to control the whole shading system
-  Scheduled task
-  Accurate control by percentage



 Voice control  App control  Communicates with other devices

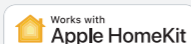

General

Model Number	BCM100D	Indicator	LED
Curtain Track Length	Maximal 3.2m/5.2m optional	Ingress Protection	IP20
Moving Speed	12cm/s	Strong Power	Yes
Rated Torque	1.2Nm	Weak Power	Yes
Operating Temperature	-20~85°C	Receiver Control	Yes
Operating Humidity	0~80%	Electronic Limit Swtich	Yes
Power Supply	100-240V AC 50/60Hz	Manual Contraol	Yes
Power Consumption	40W	3rd Intermediate Limit Position	Yes
Power Cable Length	85cm	Obstacle Stop Function	Yes
Interface	RJ11	Hand Operable During Power-off	Yes
Button	Coding / Setting button	Auto End Limits Setting	-

Radio

Radio Protocol	CoSS
Signal Range (Open Field)	100m



Construction

Color	White
Dimensions	270*50*50mm
Weight	4kg (3.2m) , 5kg (5.2m)
Casing	ABS,aluminum



Smart Curtain Motor

LS133WH

Turn your traditional curtains into smart ones

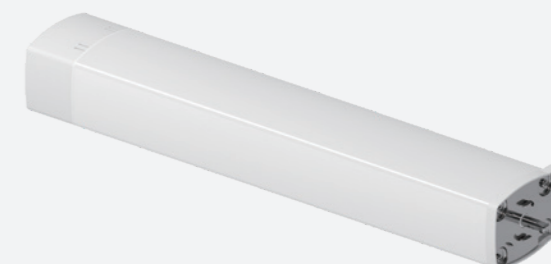
-  One tap to control the whole shading system
-  Scheduled task
-  Accurate control by percentage



 Voice control  App control  Communicats with other devices

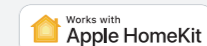

General

Model Number	LS133WH	Button	Reset/Receiver pairing button
Moving Speed	14cm/s		Smart station pairing button
Rated Torque	1.2Nm	Ingress Protection	IP40
Operating Temperature	-5~45°C	Strong Power	Yes
Operating Humidity	5~90%	Weak Power	Yes
Ingress Protection	IP40	Receiver Control	Yes
Power Supply	AC 100V-240V 50/60Hz	Electronic Limit Swtich	Yes
Power Consumption	13W	Manual Contraol	Yes
Power Cable Length	125cm	3rd Intermediate Limit Position	Yes
Interface	Serial port	Obstacle Stop Function	Yes
	Weak urrent switch interface	Hand Operable During Power-off	Yes
Indicator	LED	Auto End Limits Setting	Yes

Radio

Radio Protocol	CoSS
Signal Range (Open Field)	100m

Construction

Color	White
Dimensions	365*60*50mm
Weight	1.3KG
Casing	Aircraft aluminum

Smart Controls





The brains empower deep integration



Universal Remote Controller - SPOT

LS034SL

LS136

A fantastic IR remote controller to simplify your life by interacting with all LifeSmart product series

-  **Universal IR remote control**
-  **Unique exterior design - ornamental and also practical as a desktop storage unit**
-  **Convenient USB charge interface**
-  **16 Million colors to create various lighting effects**

 Voice control  App control  Communicate with other devices



General	
Operating Temperature	-5~45°C
Operating Humidity	5~90%
Power Supply	DC 5V
Interfaces	Micro USB power supply USB output
Button	Configuration button
Indicator	16 million color
Remote Range	360°, 5-10m
Remote Frequency	38KHz

Software	
APP Control	Yes
Voice Control	Yes
Code Library Match	Yes
Code Library Update	Yes
Remote Control Learning	Yes

SPOT (WiFi Series)	
Model Number	LS034SL
Power Consumption	≤1.3W
Radio Protocol	Wi-Fi 2.4GHz
Signal Range (Open Field)	50m



SPOT (CoSS Series)	
Model Number	LS136
Power Consumption	≤1W
Radio Protocol	CoSS
Signal Range (Open Field)	100m

Construction	
Color	Ivory white
Dimensions	128*128*53mm
Weight	260g
Casing	ABS



General Controller

LS143

A professional engineer device, updating switches/buttons/sensors of dry contact to integrate with LifeSmart system perfectly and achieve intelligent control

-  Strongly compatible for multiple smart home devices
-  Easy to integrate 3rd party devices
-  Multiple functions for light control, garage door control, etc.



 Voice control  App control  Communicates with other devices

General	
Model Number	LS143
Operating Temperature	-5~45°C
Operating Humidity	5~90%
Power Supply	DC 12V/24V
Power Consumption	Standby mode power consumption<1.5W
Maximum Overload	3A
Interfaces	5 control modes, 3 interfaces maximum



Radio	
Radio Protocol	CoSS
Signal Range (Open Field)	200m

Construction	
Color	Ivory white
Dimensions	83.6*47.0*22.3mm
Weight	50g
Casing	ABS



HA Interface Adaptor

LS155

A professional engineer device, updating switches/buttons/sensors of dry contact to integrate with LifeSmart system perfectly and achieve intelligent control

-  Compact size
-  Wall mount design, easy to incorporate
-  Multiple functions for light control, garage door control, etc.



 Voice control  App control  Communicates with other devices

General	
Model Number	LS155
Operating Temperature	-5~45°C
Operating Humidity	5~90%
Power Supply	AC 100-240V 50/60Hz
Power Consumption	<1W
Relay Overload	DC 30V 2A AC 125V 0.5A
Interfaces	HA Interface X 3 Relay Interface X 3 Input Indication Interface X 3
Indicator Light	Pairing Interface overall status (INFO) Interface status X 9
Installation	Wall mount

Radio	
Radio Protocol	CoSS
Range (Open Field)	100m

Construction	
Color	White
Dimensions	92*32*18.7mm
Weight	29g
Case	ABS+PC

DEFED Intruder Alarm Kit

Keep you safe in your home

- Tamper Prevention for All Devices
- GSM Alarm Message
- Power-off Prevention
- Compatible with Third-party Cameras
- Communicates with other smart home devices



OPEN
RESPECT
EXCELLENCE
DELIVER



HANGZHOU	10th Floor, Building A, SUPCON Information, 352 Binkang Road, Binjiang
SHENZHEN	7C, Building 1, Baisha Technology Industrial Park, No. 3011 West Shahe Road, Nanshan
BEIJING	508, Plaza C, Focus Square, 6 Futong East Street, Chaoyang District
CHENGDU	Fufu Fucheng International T1-2902, Tianfu 2nd Street, Wuhou District